

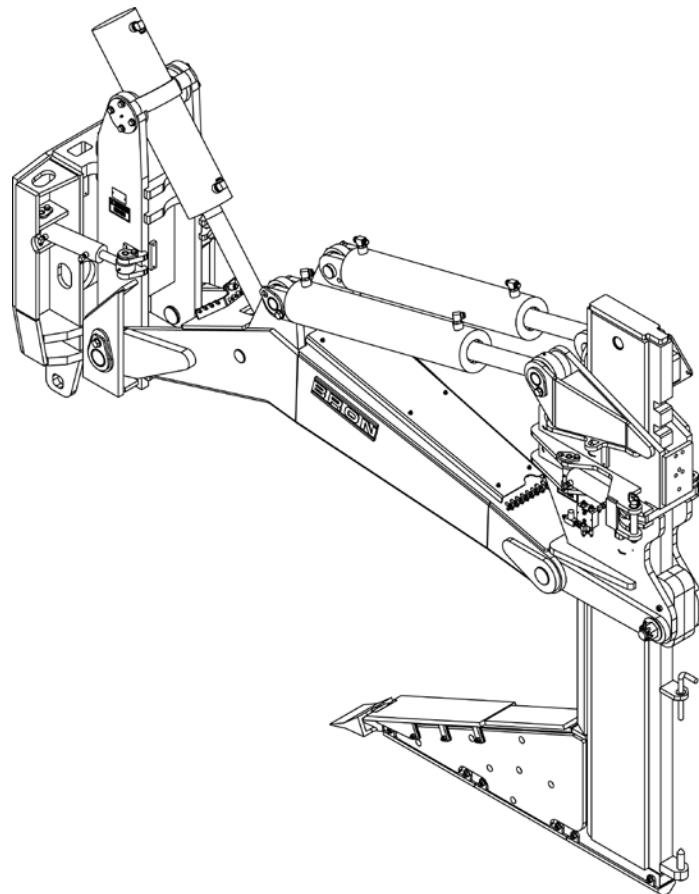

# OPERATOR'S MANUAL

## BRON BC750 PLOW



### RWF INDUSTRIES

873 Devonshire Ave., Woodstock,

Ontario N4S 8Z4

Tel: (519) 421-0036

Toll Free: 1-800-263-1060

Fax: (519) 421-0028

Email: [parts@rwfbron.com](mailto:parts@rwfbron.com)

**TABLE OF CONTENTS**

**WARRANTY..... 1**

**SAFETY..... 2**

**SAFETY SYMBOLS..... 2.1-2**

**GENERAL SAFETY PRECAUTIONS ..... 2.2-4**

**PROTECT AGAINST INJURY..... 2.5-6**

**CLEANING SAFETY..... 2.7**

**PREPARE FOR EMERGENCIES ..... 2.8**

**SAFE MAINTENANCE PRACTICES ..... 2.8-9**

**GENERAL MAINTENANCE.....2.10**

**FLUID/CHEMICAL HANDLING .....2.10-12**

**HIGH PRESSURE FLUIDS SAFETY.....2.13**

**PLOW HANDLING.....2.14**

**LOCATION & DESCRIPTION OF PLOW COMPONENTS..... 3**

**PRINCIPLES OF OPERATION ..... 4**

TABLE OF CONTENTS

BC750

OPERATOR'S MANUAL

***PRECAUTIONS..... 4.1***

***OPERATING THE PLOW..... 4.2***

***OPERATING THE TILE FEEDER & TILE CUTTER / TONNAGE CONTROL ..... 4.3***

***DISCLAIMER..... 5***



## BRON BC750 WARRANTY

### **BASE WARRANTY (12 months or 2000 hours):**

RWF Industries a Division of Roberts Welding & Fabricating Ltd. (RWF) warrants that the new BRON PLOW sold by RWF will be free from defects in material or workmanship for a period of 12 months or 2000 operating hours, whichever occurs first, starting from the date of delivery to the first user.

### **THIS WARRANTY DOES NOT APPLY TO:**

HYDRAULIC and MOUNTING INSTALLATION KIT PARTS, HOSES, OR REPLACEMENT PARTS, which are covered by other warranties

### **RWF RESPONSIBILITY:**

RWF will, at its option, repair or replace with a new or reconditioned part, any warranted part that fails by reason of defective material or workmanship, free of charge delivered at a place of business of an RWF Dealer. Note: parts replaced under warranty become the property of RWF. During the 12 month or 2000 hour BASE WARRANTY period, RWF will pay the reasonable cost of labor that is necessary to install any repaired or replacement part during normal working hours. Overtime rates and travel expenses will not be reimbursed.

### **USER RESPONSIBILITY:**

- The installer, operator, or service person, assumes responsibility to read, understand and comply with RWF's written INSTALLATION, OPERATOR, SERVICE AND WELDING INSTRUCTIONS
- All costs associated with transporting the attachment and/or equipment to an authorized location.
- RWF is not responsible for any expense incurred in field repair.
- Supplying a hydraulic oil sample from the carrier machine based on the following schedule:
  - 1st SAMPLE at the 100 HOUR SERVICE (break-in period)
  - 2nd SAMPLE at the 3 MONTH period (±4 weeks)
  - 3rd SAMPLE at the 6 MONTH period (±4 weeks)
  - 4th (last) SAMPLE at the 9 MONTH period (±4 weeks)

### **THESE WARRANTIES DO NOT COVER FAILURES RESULTING FROM:**

- Installation, alteration, operation, maintenance, repair or storage which RWF judges improper.
- Not performing DAILY VISUAL INSPECTIONS AND RETIGHTENING as specified in RWF Manuals.
- Not following RWF's recommended welding procedure.
- Operation after discovery of defective or worn parts.
- Unreasonable delay in making a repair after being notified of a potential problem.
- Acts of God, war, vandalism, riot, theft, explosion, and any other act of nature or man

### **THESE WARRANTIES SPECIFICALLY EXCLUDE:**

- Installations not approved by RWF.
- Hardface welding to build up wear on surfaces.
- Replacement due to wear.
- Ground engaging tools. Points, guards, blades etc
- Repairs by other than an authorized RWF Dealer.

- Any alteration to BRON products.
- Use of parts not sold by RWF.
- Labor charges deemed excessive by RWF.
- Parts shipping charges in excess of those, which are usual and customary.
- Duty and local taxes.

**LIMITATIONS AND EXCLUSIONS:**

Violation of any federal, provincial, state or local laws, ordinances, rules or regulations, or removal or alteration of product serial numbers void RWF's written product warranties. The written product warranties made by RWF set forth RWF's only obligations with respect to any claims of failure, defects or deficiencies in products sold by RWF. RWF MAKES NO OTHER WARRANTIES OR REPRESENTATIONS WHATSOEVER, EXPRESS OR IMPLIED, OF THE QUALITY, PERFORMANCE, DURABILITY, MATERIALS, WORKMANSHIP, SUITABILITY, CONDITION, DESIGN OR UTILITY OF PRODUCTS SOLD BY RWF, INCLUDING, WITHOUT LIMITATION, IMPLIED WARRANTIES OR MERCHANT ABILITY AND FITNESS. ALL SUCH OTHER WARRANTIES AND REPRESENTATIONS BEING HEREBY EXPRESSLY EXCLUDED. RWF SHALL NOT BE LIABLE FOR SPECIAL INCIDENTAL OR CONSEQUENTIAL DAMAGES INCLUDING WITHOUT LIMITATION, COSTS, LOSSES, OR LIABILITIES ON ACCOUNT OF DELAY OR DOWNTIME.

**DISCLAIMER REGARDING OTHER REPRESENTATIONS OR WARRANTIES:**

No person is authorized to grant any other warranties or to assume any other liability on RWF's behalf unless made or assumed in writing by an officer of RWF. No person to grant any warranties or to assume any liabilities on the seller's behalf unless made or assumed in writing by the seller. As used in this warranty the term RWF means, RWF Industries, a division of Roberts Welding and Fabricating Ltd, Woodstock, Ontario, Canada.

**SOME ITEMS NOT COVERED BY WARRANTY:**

Items and service related functions that are not covered by warranty include, but are not limited to:

- Issues resulting from misuse, negligence or accident.
- Issues arising from the use of non-approved parts.
- Repair or adjustment by other than RWF or its authorized dealers.
- Issues resulting from the installation of unauthorized attachments or modifications.
- Tightening of nuts, bolts, screws, etc. or adjustments.
- Natural wear or defects caused by natural wear.
- Issues due to use of improper grease or other lubricant.
- Daily allowances and overtime labor rates.
- Indirect damages such as loss of earning, etc.
- Normal maintenance services. Maintenance services not directly involved with defective parts are considered normal service and should be excluded from a claim.
- These services include (but not limited to):
- Tightening of hydraulic fittings.
- Hydraulic pressure adjustments.

# SAFETY

## SAFETY SYMBOLS

### *Safety Alert Symbol*



This **safety-alert** symbol is used throughout the manual to call attention to areas in which carelessness or failure to follow specific procedures may result in personal injury, death, and/or component damage or malfunction. It is the obligation of the operator to make sure that all warning decals are in place on the machine and that they are readable. Accidents may occur.

### *Signal Words*

#### **DANGER**



Identifies the most serious hazards where failure to follow listed procedures would result in a high probability of serious injury or death.

#### **WARNING**



Denotes a hazard exists which can result in serious injury or death if proper precautions are not taken.

**CAUTION**

**Is used in areas where failure to follow listed procedures may cause injury, component damage or subsequent malfunction.**

**NOTE**

Outline general safety rules or additional procedural guidelines which should be followed when checking and servicing the plow.

**GENERAL SAFETY PRECAUTIONS**

RWF Industries a Division of Roberts Welding & Fabricating Ltd's. (RWF BRON) policy is to produce products that are safe and reliable. However, even when using well-engineered equipment, there will always be an element of risk in heavy-duty equipment operation. To minimize the risks and promote safety at all times, this manual details a number of safety rules, which should always be followed and obeyed.

This manual should be accessible with the plow when in operation so it is available for all operators.

Study all the safety messages in this manual and on the machine carefully. Any person, who does not follow the safety instructions or fails to read the warnings given in this manual, must make sure that his or her working method is safe. Otherwise there is risk of serious, even fatal, accidents.

You must be fully trained to operate this equipment or similar equipment. Know the capabilities and the limitations of the equipment. Learn the most efficient operating techniques.

Do not let an untrained person operate this plow.

**NOTE**

When it comes to safety, nothing will ever replace a careful operator.

These safety rules highlight both general and specific measures the operator should be familiar with and adhere to. More specific measures are illustrated with decals, which may also be attached to the plow in locations pertinent to their respective message. Keep safety signs and decals in good condition and repair or replace damaged signs/decals.

### ***General Operation***

- Operate the plow only when physically fit and not under the influence of alcohol or drugs.
- Inspect the plow daily for signs of damage, unusual wear, fluid leaks, or faulty operation.
- Do not operate the plow with any devices removed.
- Consult and understand the manufacturer's instructions and/or labels before you start any job using hazardous chemicals.
- When moving the plow, watch that enough clearance is available on both sides and above the attachment. Extra clearance may be required, particularly where the ground is uneven.
- Approach an area where electrical power lines are present with extreme caution. Serious injury or death by electrocution can result if the plow is not kept a safe distance from these lines.
- Maintain a distance of 10' (3 m) between the plow and any power line carrying up to 50,000 volts or less.
- Power lines carrying more than 50,000 volts require a safety distance of 10' (3 m) plus ½" (12.7 mm) for each additional 1,000 volts above the 50,000 volt level. If state/province, local or job site regulations require even greater safety distances than stated above, adhere strictly to those regulations for your own protection.
- Comply with the instructions in this manual and your company's regulations for the operation of this plow.
- Should there be any information or instructions in this manual that are not in compliance with local laws and regulations in place in the country or region where this equipment is operated, the local laws and regulations must take precedence.
- As the owner/maintainer, ensure that you become familiar with all of the occupational safety regulations pertaining to this equipment. Observe the instructions in this manual and all hazard decals on the equipment.

### ***Protective Clothing***



**Head  
Protection**



**Foot  
Protection**



**Eye  
Protection**



**Hearing  
Protection**

- Wear close fitting clothing and safety equipment appropriate to the job.
- Long hair should be tied behind your head.
- All jewellery, including rings, should be removed to prevent entanglement in moving parts.



**WARNING**

Operating equipment safely requires the full attention of the operator. Do not wear radio or music headphones while operating the plow.

***Starting Precautions***

Walk around the plow. Check for loose or missing parts, excess wear, trash build-up, and fluid leaks. Visually inspect the condition of other items such as:

- Hose, cylinders, controls, and instruments
- Safety equipment
- Hydraulic system

Report any leaks, wear or damage. If any of these conditions exist, fasten a 'DO NOT OPERATE' or similar warning tag to a suitable location on the equipment. Prior to using the plow, check for the 'DO NOT OPERATE' or similar warning tags. Never start or continue to operate a plow knowing an unsafe condition exists, always check the proper function or controls prior to starting work.

***Stopping Precautions***

- Stop at a reasonable distance from other equipment.
- Park the machinery that the plow is affixed to in a safe position.
- Lower all equipment to the ground.
- Stop the engine of the machinery that the plow is affixed to.
- Always park the equipment completely off of highways and roads.
- Set up safety cones, red flags, red lights, or flares if parking near traffic areas is necessary.

## PROTECT AGAINST INJURY

### *Pay Attention to Bystanders*

- Operate the plow only when physically fit and not under the influence of alcohol or drugs.
- Before you move the plow, always look around and use a signal person where necessary.

### *Protect Against Flying Debris*

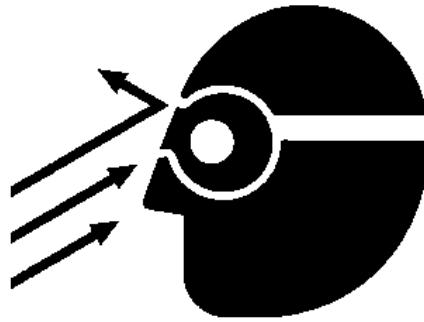

When driving connecting pins in or out, guard against injury from flying pieces of metal or debris. Always wear goggles or safety glasses.

### *Avoid Hot Parts*



Skin contact with hot hydraulic cylinders, hydraulic pumps and lines, or any other hot compartments should be avoided.

### ***Stay Clear of Moving Parts***

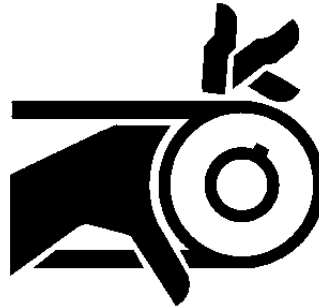

- Entanglement in moving parts can cause serious injury.
- To prevent accidents, use extreme caution when working around rotating parts.
- Never operate the plow with missing, loose, damaged, or open shields or guards.

### ***Protect Against Noise***



- Prolonged exposure to loud noise can cause impairment or loss of hearing.
- Wear a suitable hearing protective device such as earmuffs or earplugs to protect against objectionable and uncomfortably loud noises.

## CLEANING SAFETY

### *Clean the Plow Regularly*

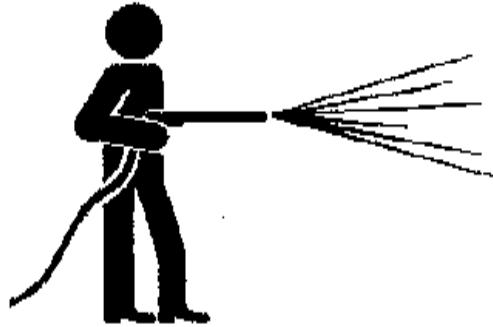

- Remove any grease, oil or debris build-up to avoid possible injury or plow damage.

### **WARNING**



**NEVER use gasoline as cleaning solvent.**

## PREPARE FOR EMERGENCIES

- Be prepared if a fire starts.
- Keep a first aid kit and fire extinguisher handy.
- Keep emergency numbers for doctors, ambulance service, hospital, and fire department near or in your phone.

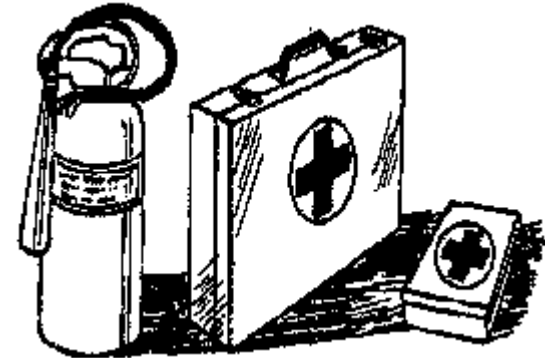

## SAFE MAINTENANCE PRACTICES

### *Inspect Plow*

- Inspect the plow carefully each day.
- Walk around it before you start using it.
- Ensure all maintenance schedules are followed to keep the plow running properly, safely, and efficiently.



### *Before Working on the Plow*

- Park plow and machinery that plow is attached to on a level surface.
- Lower all attachments to the ground.
- Engage parking break of machinery that plow is attached to.
- Turn the key in the ignition switch to the off position to stop the engine, and then remove the key of the machinery that the plow is attached to.



### ***Warn Others of Service Work***

- Unexpected plow movement can cause serious injury.
- Before performing any work on the plow, attach a “DO NOT OPERATE” tag to the dash of machine it is attached to, to alert others of service work being performed.
- Remove the engine key and master key switch of the machinery that the plow is attached to.

### ***Understand Service Procedures***

- Keep the plow clean and dry.
- Never lubricate or service the plow while it is in use.
- Keep hands, feet, and clothing away from any power-driven parts.
- Lower equipment to the ground, stop the engine, remove the key, and allow the machinery to cool.
- Securely support any plow elements that must be raised for service work.
- Keep all parts in good condition and properly installed.
- Fix damage immediately.
- Replace worn or broken parts immediately.
- Remove any build-up of grease, oil, or debris.
- Replace worn, damaged, or faulty parts only with components meeting the manufactures specifications.
- After a maintenance procedure, verify that any loosened or removed fasteners have been properly installed and tightened.



## GENERAL MAINTENANCE

### *Welding and Grinding Work*

#### **WARNING**



**DO NOT WELD ON THE SHANK OR LINKAGES.  
(They are made from heat-treated alloy steel)**

## FLUID/CHEMICAL HANDLING

#### **WARNING**



**Consult and understand the manufacturer's instructions and/or labels before you start any job using hazardous chemicals.**

### ***Handle Chemical Products Safely***

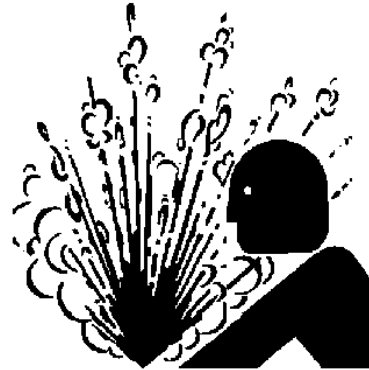

#### **WARNING**



**Direct exposure to hazardous chemicals can cause serious injury.**

- Potentially hazardous chemicals used with BRON® plows include, but are not limited to, such items as lubricants, paints, and adhesives
- Store chemicals away from the machine.
- Material Safety Data Sheets (MSDS) for products, purchasable from RWF Industries, can be requested from RWF Industries customer service.
- The MSDS will provide information about the chemical substances within the product you are using, the safe handling procedures, the first aid measures, and the procedures to be taken when the product is accidentally spilled or released and should be referenced before servicing the equipment.



### *Dispose of Waste Properly*

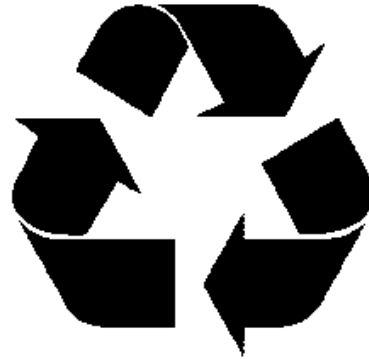

- Improperly disposing of waste can threaten the environment and ecology. Potentially harmful waste used with BRON® plows includes, but is not limited to, such items as oil, grease, and other fluids.
- Use leak proof containers when draining fluids. Do not use food or beverage containers to hold hazardous chemicals. This may mislead someone into drinking from them.
- Do not pour waste onto the ground, down a drain, or into any water source.
- Inquire on the proper way to recycle or dispose of waste from your local environmental or recycling centre.

## HIGH PRESSURE FLUIDS SAFETY

### *Avoid High-Pressure Fluids*



- Escaping fluid under pressure can penetrate the skin causing serious injury.
- Avoid hazard by relieving pressure before disconnecting hydraulic or other lines.
- Please note that if your plow is equipped with an accumulator extra precaution is needed when relieving the hydraulic pressure.
- Tighten all connections before applying pressure.

### **WARNING**



**Never check for leaks with your hand or any other body part.**

- Search for leaks with a piece of cardboard. Protect your hands and body from high-pressure fluids.
- If an accident occurs, see a doctor immediately. Any fluid injected into the skin must be surgically removed within a few hours or gangrene may result. Doctors unfamiliar with this type of injury may call the Centers for Disease Control (CDC) 1-800-232-4636, or other knowledgeable medical sources.

## PLOW HANDLING

### *Support Plow Properly*

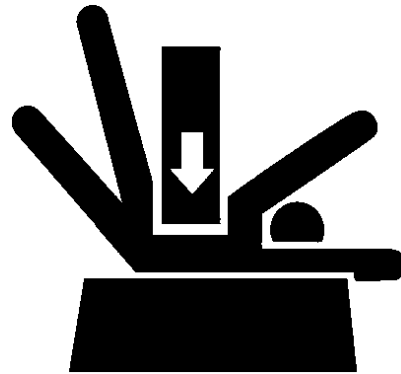

- Always lower the plow to the ground before you work on it. If you must work on a lifted plow, securely support it first.
- Do not support the plow on cinder blocks, hollow tiles, or props that may crumble under continuous load. Do not work under a plow that is supported solely by a jack. Follow recommended procedures.

# LOCATION & DESCRIPTION OF PLOW COMPONENTS

## *BC750 PLOW COMPONENTS*



***Main Lift Cylinder***

The main lift cylinder (1) is used to raise and lower the entire plow assembly.

***Pitch/Attitude Cylinders***

The pitch/attitude cylinders (2) are used to adjust the pitch/attitude of the plow blade.

***Swing Cylinders***

The swing cylinders (3) are used to swing the plow assembly left or right and can be placed in float.

***Laser Mast Raiser Cylinder (If Equipped)***

The laser mast raiser cylinder raises and lowers the laser mast raiser.

***Laser Mast Raiser (If Equipped)***

The laser mast raiser is used to lift the laser mast higher above the machine.

***Blade Lock Cylinder and Pin (If Equipped)***

When the pin is removed, the blade lock cylinder is used to release the plow blade for height adjustment.

# PRINCIPLES OF OPERATION

## **PRECAUTIONS**

Read and follow all safety precautions outlined in the Operator's Manual before operating the plow.

### **CAUTION**



**Hearing protection is required to operate this machine.**

### **DANGER**



**Serious injury or death by electrocution can result if the plow is not kept a safe distance from power lines.**

Maintain a distance of 10' (3 m) between the plow and any power line carrying up to 50,000 volts or less.

## ***OPERATING THE PLOW***

Ensure the controls are not in REEL SELECT mode before operating the plow.

### **NOTE**

The instructions below are for the common control configuration. Your machine's controls may be opposite to those listed.

### ***Adjusting the Attitude/Pitch of the Plow Blade***

The plow blade is angled towards the machine by pulling the REEL/REAR LIFT JOYSTICK towards the operator. This will cause the plow blade/shank to ride out of the ground. The plow blade is angled away from the machine by pushing the REEL/REAR LIFT JOYSTICK away from the operator. This will cause the plow blade to ride deeper into the ground. Once desired depth has been achieved, only use the MAIN LIFT JOYSTICK or grade control to maintain desired depth.

### ***Raising and Lowering the Plow Assembly***

The plow assembly is raised by pulling the PLOW SWING/PLOW LIFT JOYSTICK towards the operator. The plow assembly is lowered by pushing the PLOW SWING/PLOW LIFT JOYSTICK away from the operator.

### ***Swing Plow Assembly***

The plow assembly is swung right by pulling the PLOW SWING/PLOW LIFT JOYSTICK to the right. The plow assembly is swung left by pulling the PLOW SWING/PLOW LIFT JOYSTICK to the left.

### ***Placing Plow Assembly in Float***

The plow assembly is placed in float by setting the lift float switch to PLOW FLOAT. The plow assembly is placed in swing float using the SWING FLOAT switch.

## ***OPERATING THE TILE FEEDER/TILE CUTTER***

### ***Activating Power Feeder***

The TILE FEEDER switch on the seat console turns on the tile puller and tile feeder. Push the switch once to turn on the feeder and push again to turn off the feeder. The speed of the tile feeder can be adjusted using TILE SPEED CONTROL knob on the RH console.

### ***Swing Power Feeder***

If the machine is equipped with a hydraulic swing power feeder, the power feeder is swung left or right using the FEEDER SWING switch on the seat console. If the machine is not equipped with a swing power feeder, the power feeder can be swung by hand.

### ***Cutting Tile***

Use the TILE CUTTER switch to cut the tile.

## ***TONNAGE CONTROL***

Tonnage control can be used to offset the weight of the plow or apply down pressure to keep the plow in balance in a variety of soil conditions. Set the tonnage direction switch to TONNAGE FORCE UP when the plow is sinking into soft soil and to TONNAGE FORCE DN when the plow is being forced up by hard soil. Use the INCREASE/DECREASE TONNAGE switch to increase or decrease the pressure to the plow lift cylinder until balance is obtained.







